



# 温差发电水泥基复合材料研究进展

报告人：冯闯

南京工业大学土木工程学院

# 报告提纲

1

研究背景

2

理论建模

3

实验制备与测试

4

结果与讨论

5

报告小结

1

# 研究背景

2021年3月15日，中央财经委员会第九次会议中首次提出：“构建**清洁低碳安全**高效的能源体系，实施**可再生能源替代行动**，构建以**新能源为主体**的新型电力系统”

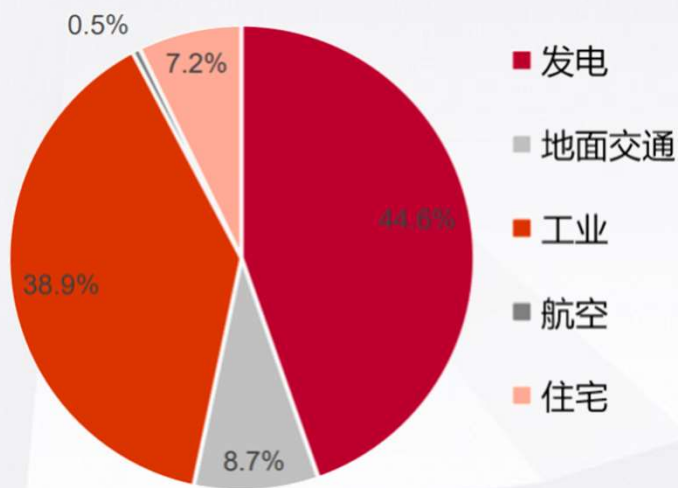

中国碳排放最主要来源

### 碳目标实现路径规划



中国碳中和实现路径



工业废热

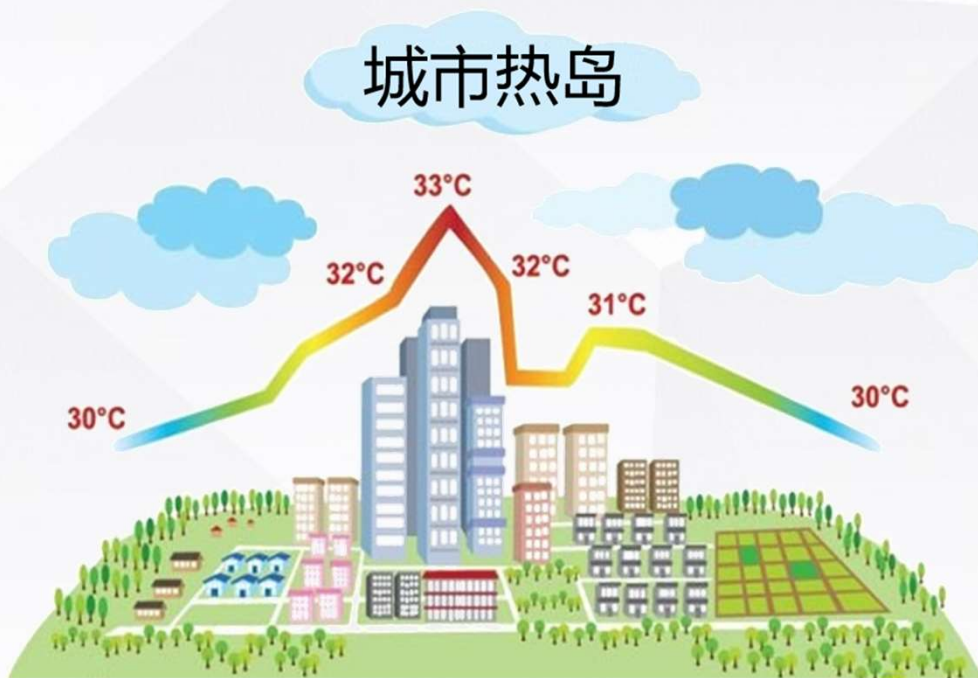

建筑集群



车辆摩擦

城市热岛效应严重影响了生态环境和人们的居住环境，加速能源消耗



日光照射



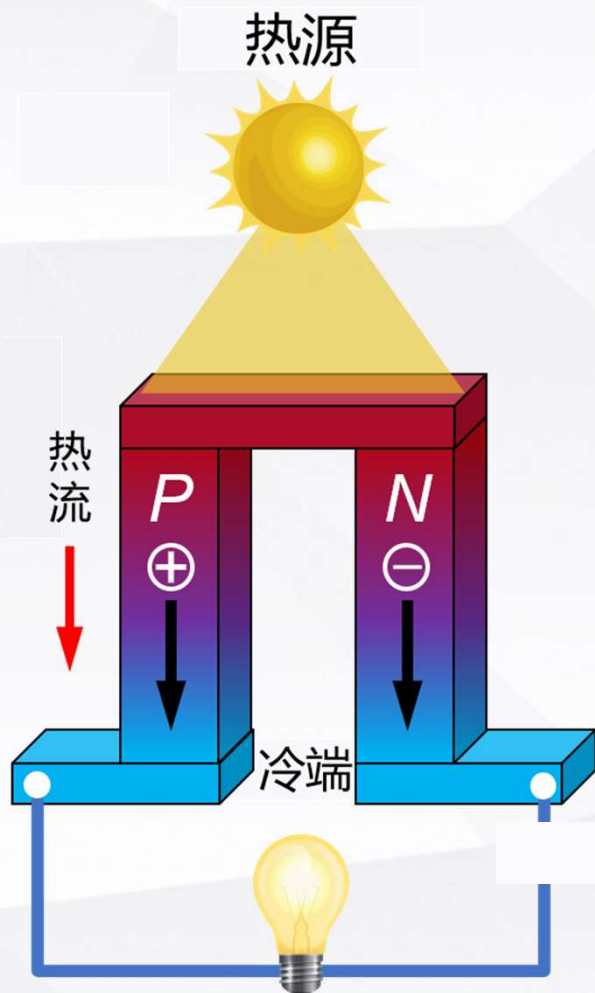

## 温差发电原理 (热电效应)

塞贝克效应：温差引起材料内部载流子迁移和堆积产生电势差

帕尔贴效应：电流通过材料时，材料两端出现吸热和放热

热电优值  $ZT = \frac{\sigma}{\kappa} S^2 T$

导电性是热电性能基础，对其制备热电水泥基样品提供理论依据，指导样品设计和优化

## 碳中和实现路径与基础保障



## 温差发电水泥基复合材料助力“双碳计划”

### -能源供给端-

➤可实现**清洁能源发电**及**电力脱碳**

➤优点：无噪音、无污染、无温室气体排放...

### -能源使用端-

➤建筑表面的能量收集，供应应急设备

➤路面发电供应信号灯、路灯

# 石墨烯

低维度 纳米结构

电子迁移率达到**15000**  $\text{cm}^2/(\text{V}\cdot\text{s})$ ，是硅的**10**倍

杨氏模量达到**1.0** TPa，拉伸强度达到**130** GPa

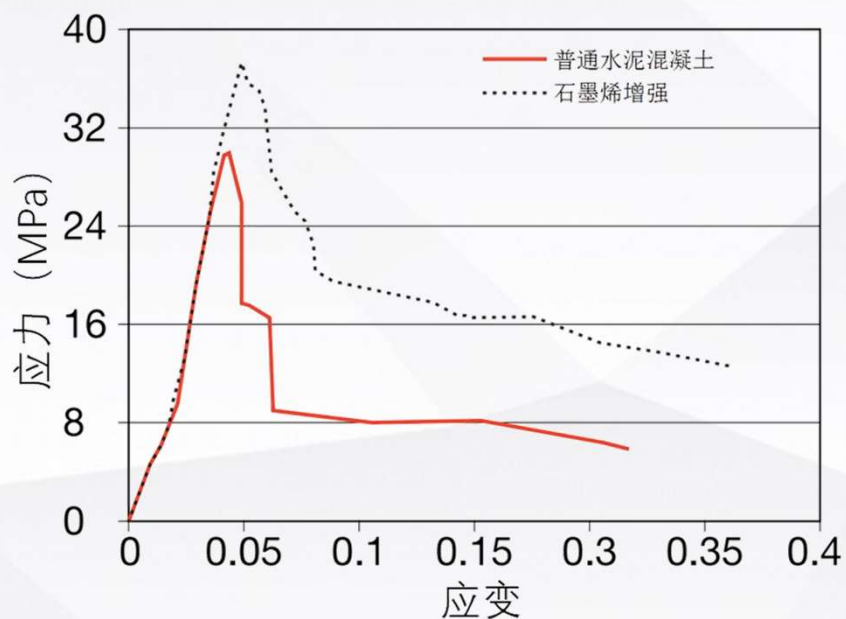
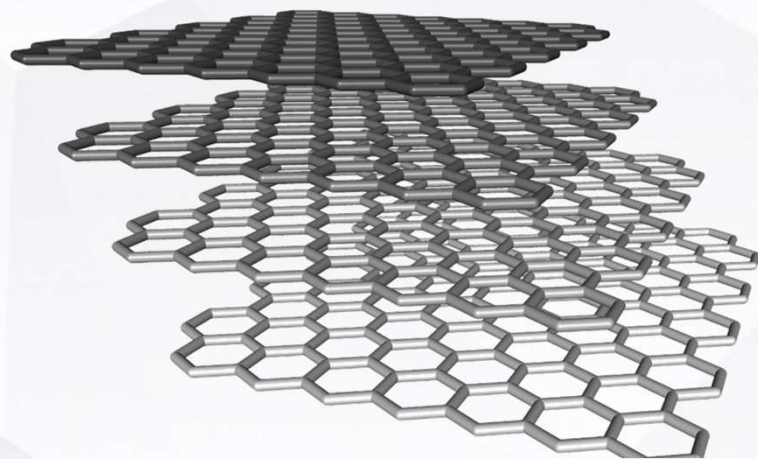

- 石墨烯可以增强水泥基复合材料力学性能
- 石墨烯可以提高复合材料的导电率



2

## 理论建模

---

# 有孔隙浸润的水泥基复合材料

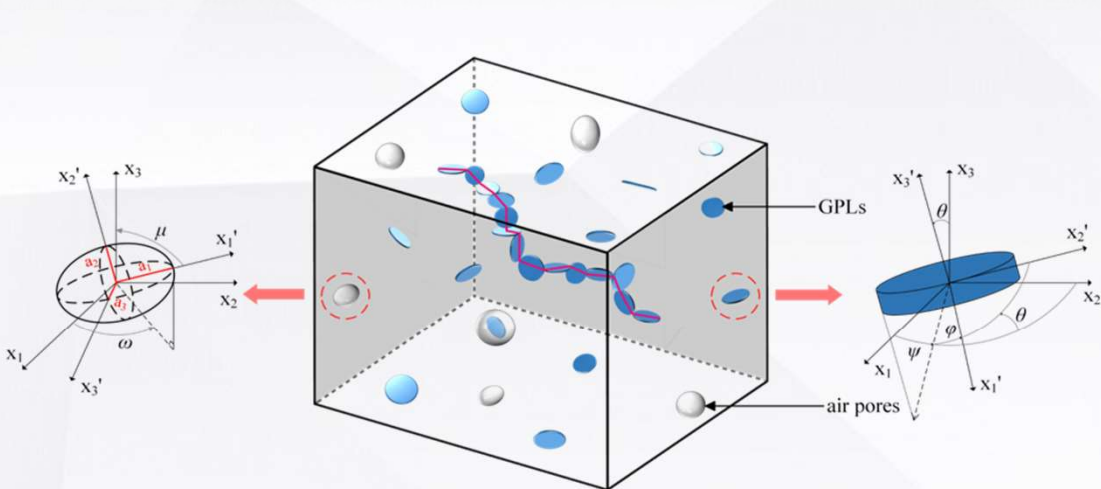

代表性体积单元

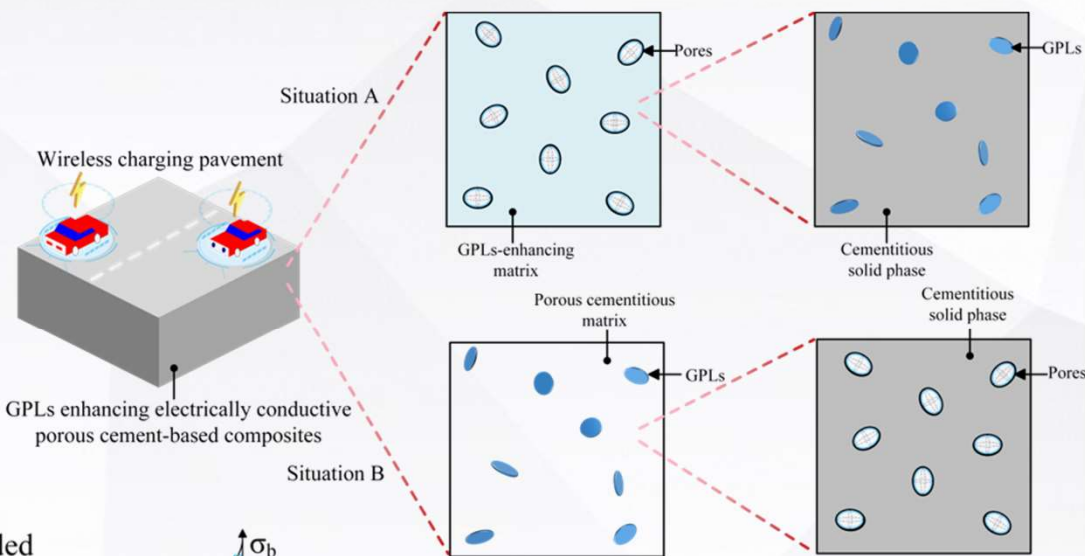

孔隙模型示意图

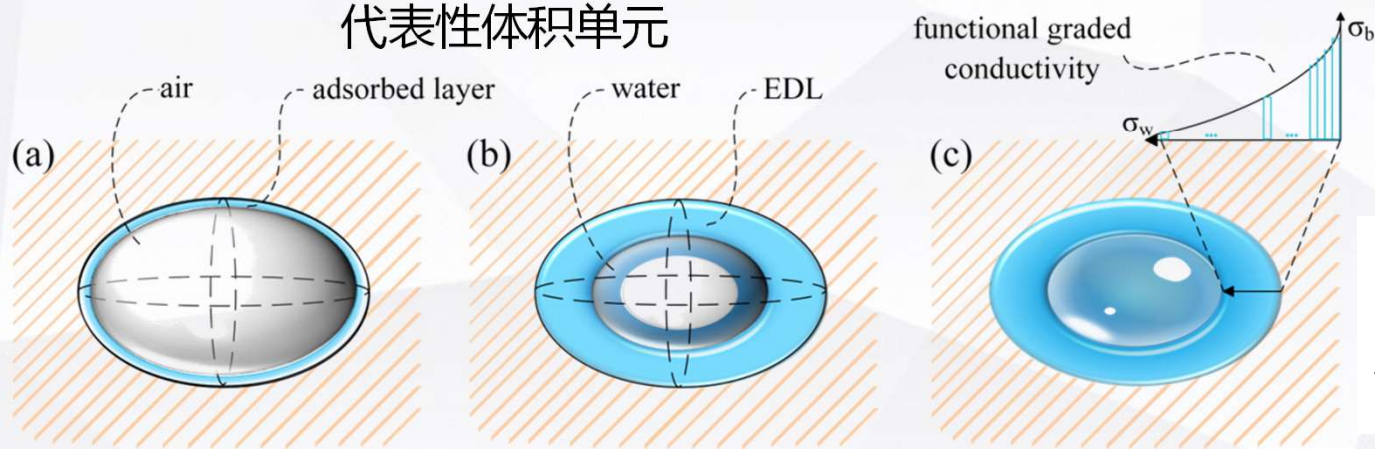

功能梯度双电层模型示意图

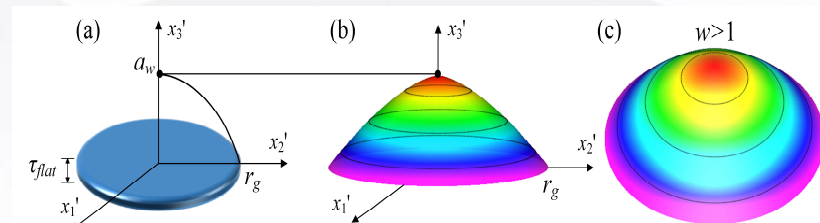

石墨烯片褶皱

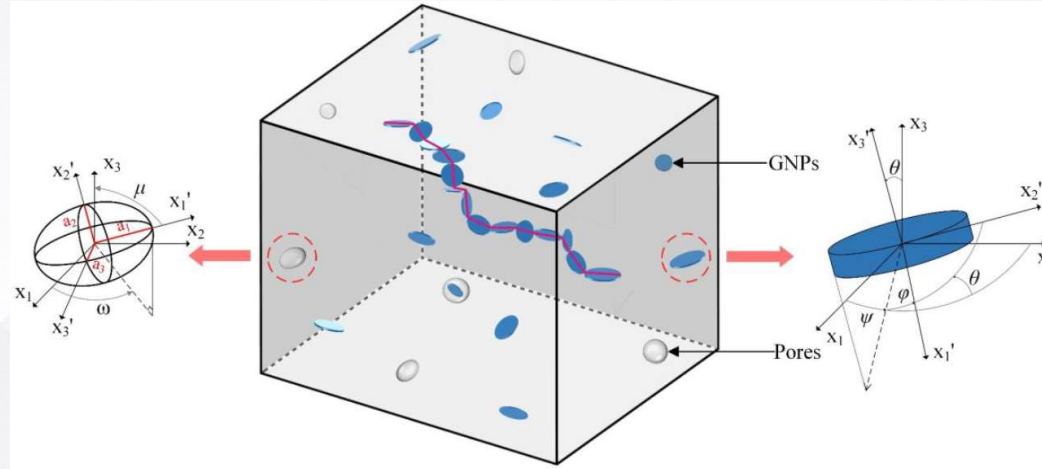

**Modulus Tensor**

$$\mathbf{W}_{mg} = c_m \mathbf{W}_m + c_g^{flat} \mathbf{W}_g, \quad \text{where } \mathbf{W}_k = \left[ (\boldsymbol{\sigma}_k - \boldsymbol{\sigma}_r)^{-1} + \mathbf{S}_k \boldsymbol{\sigma}_k^{-1} \right]^{-1}$$



$$\left[ (\boldsymbol{\sigma}_{mg} - \boldsymbol{\sigma}_r)^{-1} + \mathbf{S}_{mg} \boldsymbol{\sigma}_r^{-1} \right]^{-1} = c_m \left[ (\boldsymbol{\sigma}_m - \boldsymbol{\sigma}_r)^{-1} + \mathbf{S}_m \boldsymbol{\sigma}_r^{-1} \right]^{-1} + c_g^{flat} \left[ (\boldsymbol{\sigma}_g - \boldsymbol{\sigma}_r)^{-1} + \mathbf{S}_g \boldsymbol{\sigma}_r^{-1} \right]^{-1}$$

**Randomly Dispersed**

$$c_m \frac{\sigma_m - \sigma_{mg}}{\sigma_{mg} + (1/3)(\sigma_m - \sigma_{mg})} + \frac{1}{3} c_g^{flat} \left[ \frac{2(\tilde{\sigma}_{g,in}^{flat} - \sigma_{mg})}{\sigma_{mg} + S_{11}(\tilde{\sigma}_{g,in}^{flat} - \sigma_{mg})} + \frac{\tilde{\sigma}_{g,out}^{flat} - \sigma_{mg}}{\sigma_{mg} + S_{33}(\tilde{\sigma}_{g,out}^{flat} - \sigma_{mg})} \right] = 0$$



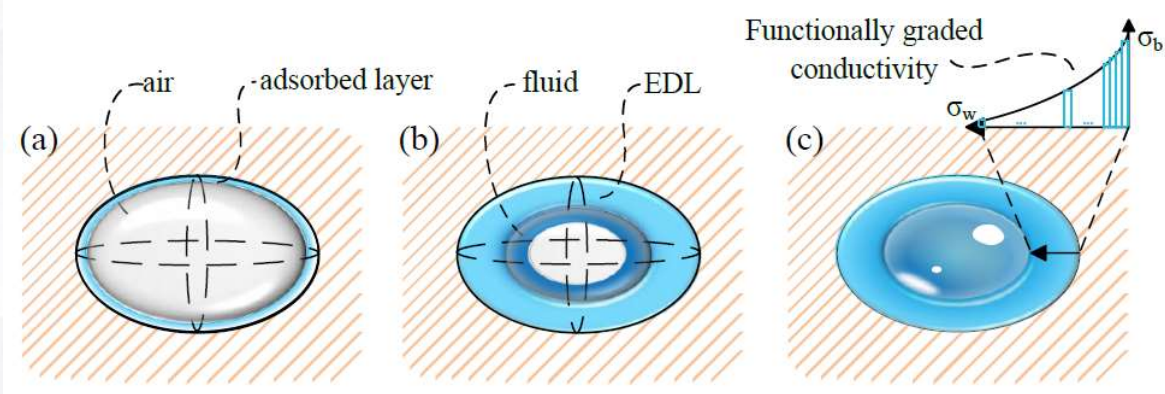

$$\sigma_p^j = \sigma_{EDL} \left[ 1 + \frac{\left( \frac{\alpha_p a_1^3}{(a_1 + t_{EDL})^2 (\alpha_p a_1 + t_{EDL})} \right) (\sigma_{wa}^j - \sigma_{EDL})}{\left( 1 - \frac{\alpha_p a_1^3}{(a_1 + t_{EDL})^2 (\alpha_p a_1 + t_{EDL})} \right) S_{ij} (\sigma_{wa}^j - \sigma_{EDL}) + \sigma_{EDL}} \right]$$

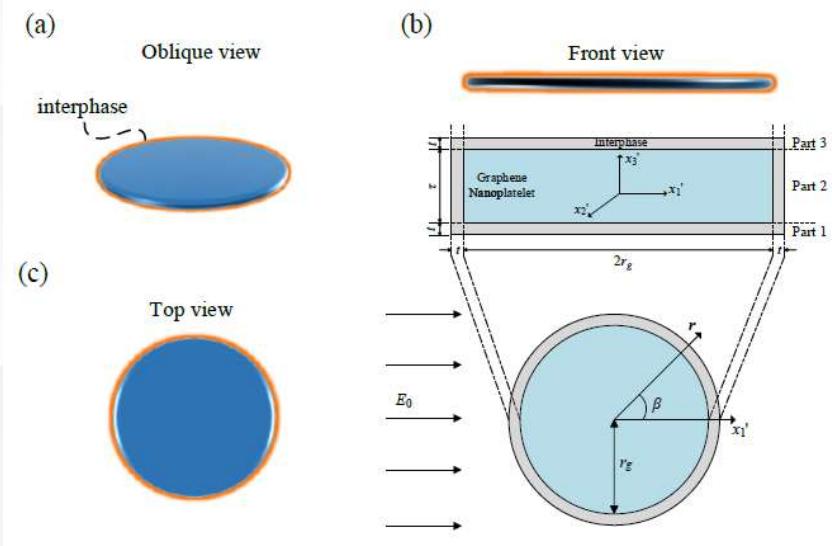

$$\tilde{\sigma}_{g,in}^{flat} = \frac{\sigma_{int}}{\tau_{flat} + 2t} \left[ \tau_{flat} \frac{2r_g^2 \sigma_{g,in}^{flat} + (\sigma_{g,in}^{flat} + \sigma_{int})(t^2 + 2r_g t)}{2r_g^2 \sigma_{int} + (\sigma_{g,in}^{flat} + \sigma_{int})(t^2 + 2r_g t)} + 2t \right]$$

$$\tilde{\sigma}_{g,out}^{flat} = \frac{(2t + \tau_{flat}) \sigma_{int} [r_g^2 \sigma_{g,out}^{flat} + (2r_g t + t^2) \sigma_{int}]}{2r_g^2 \sigma_{g,out}^{flat} t + 2\sigma_{int} (2r_g t + t^2) t + \sigma_{int} (r_g + t)^2 \tau_{flat}}$$

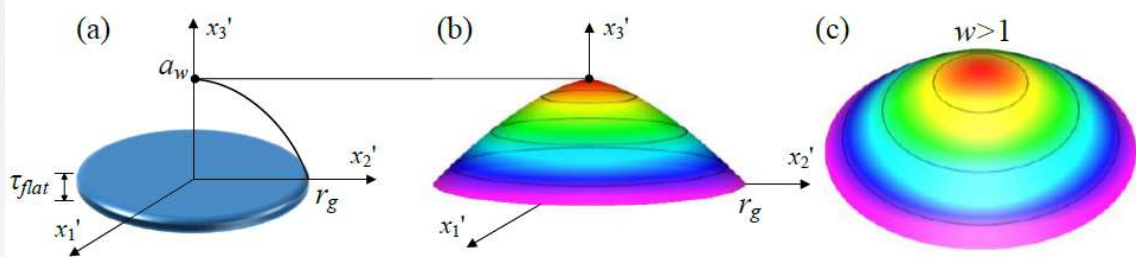

$$\sigma_{g,in}^{flat} = \frac{r_g}{\int_0^{r_g} L_{ripple} dx_2'} \sigma_{g,in}^{ripple}, \quad \sigma_{g,out}^{flat} = \frac{A_{ripple}}{\pi r_g^2} \sigma_{g,out}^{ripple}$$



## 两步法混合型微观力学模型

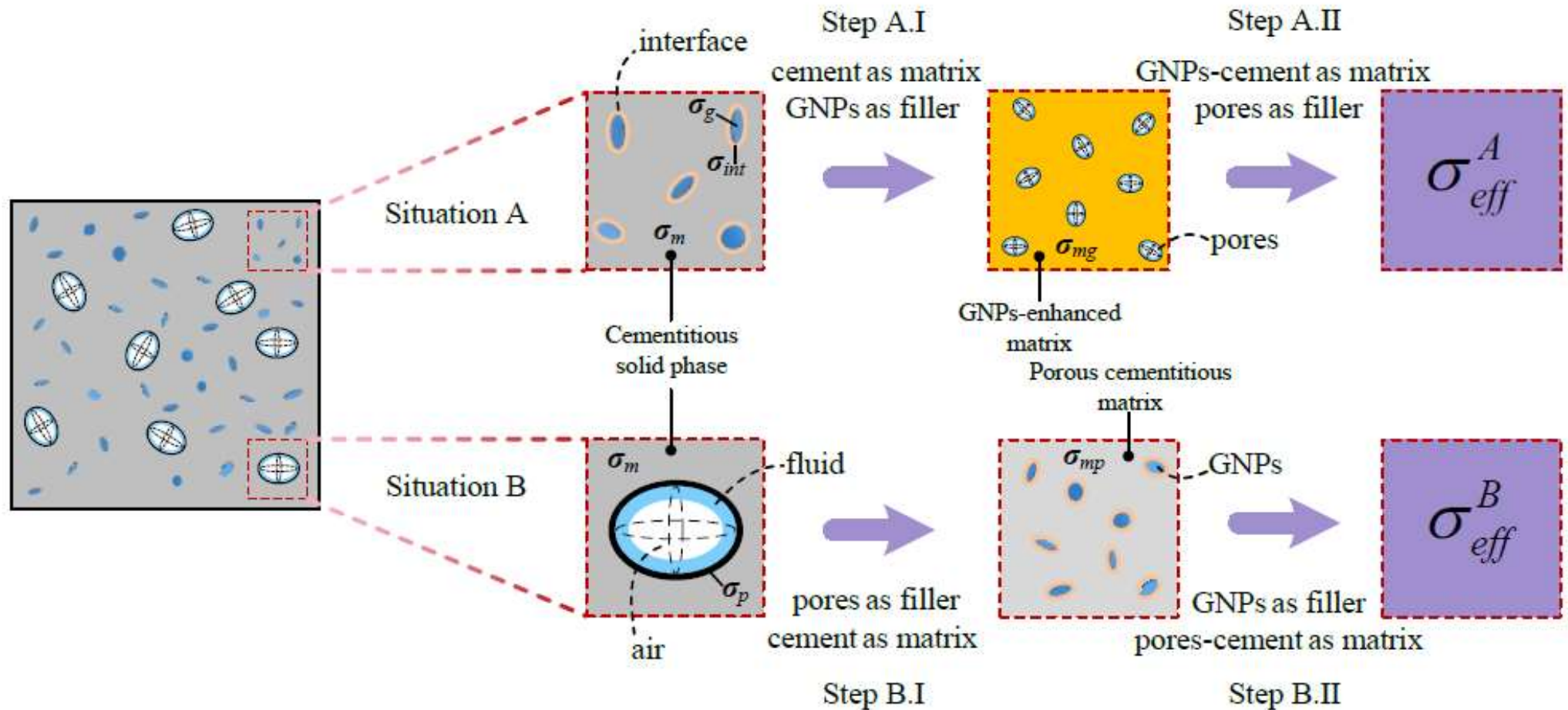

4

实验制备

---

# 制备与测试方法

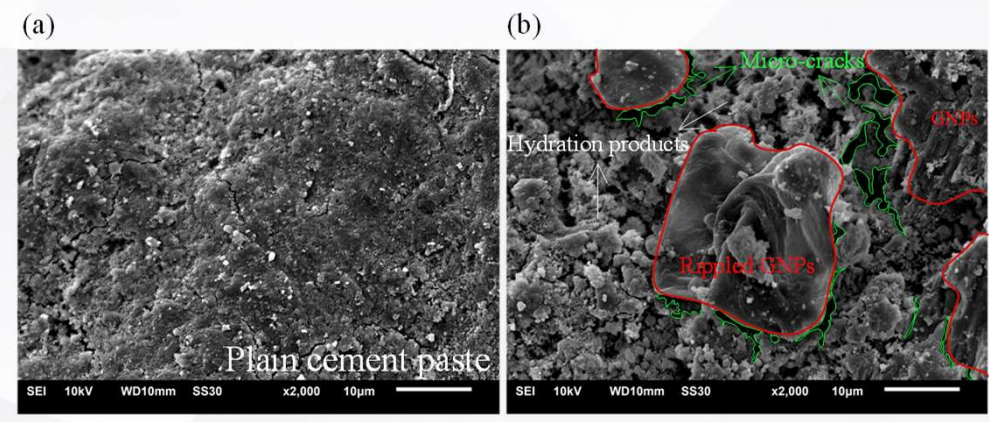
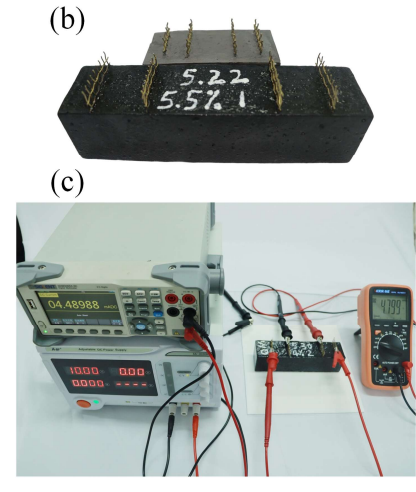
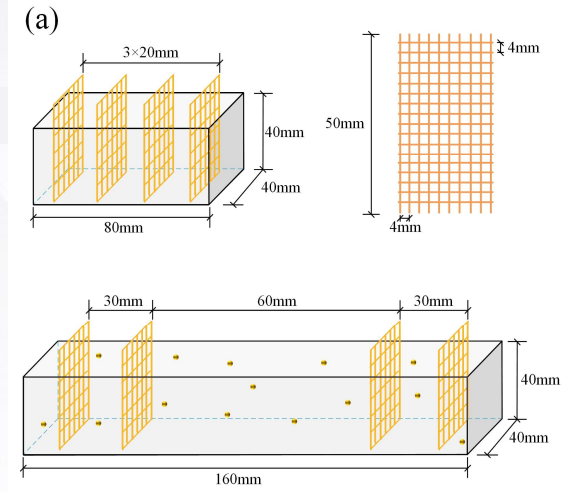
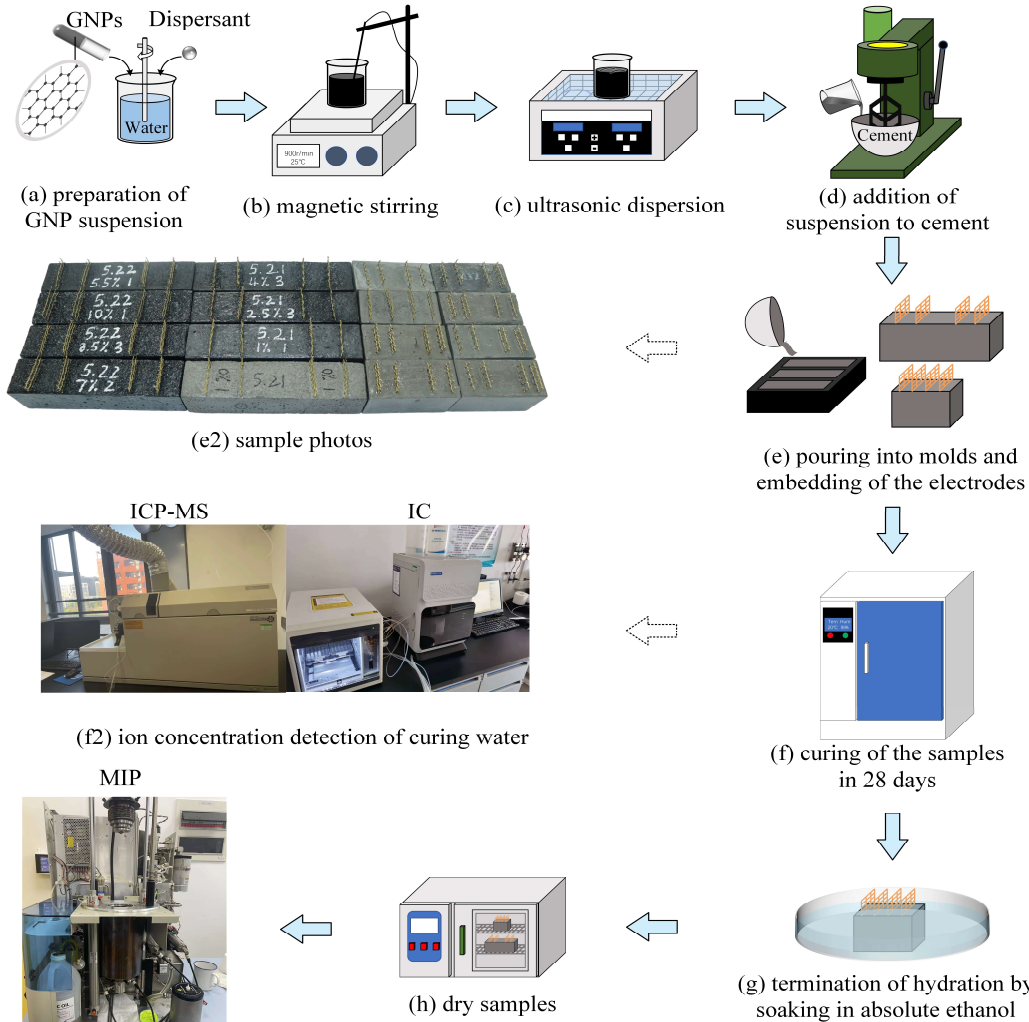



## 样品展示与场景模拟



成功点亮额定电压为2V的LED指示灯



# 建筑表面能量收集

## 1 夏冬季不间断发电

夏冬季室内外温差发电

## 2 发储供一体化结构

整合温差发电、储电、供电单元

## 3 全桥电路实时充放电

储存温差电能，为小型应急设备供电

## 前景化应用场景一

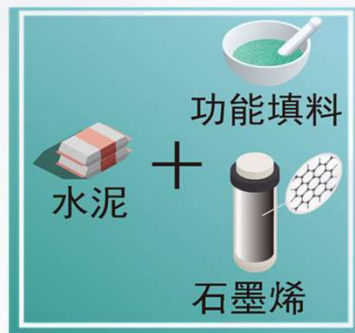

温差发电  
水泥基复合材料



建造大楼

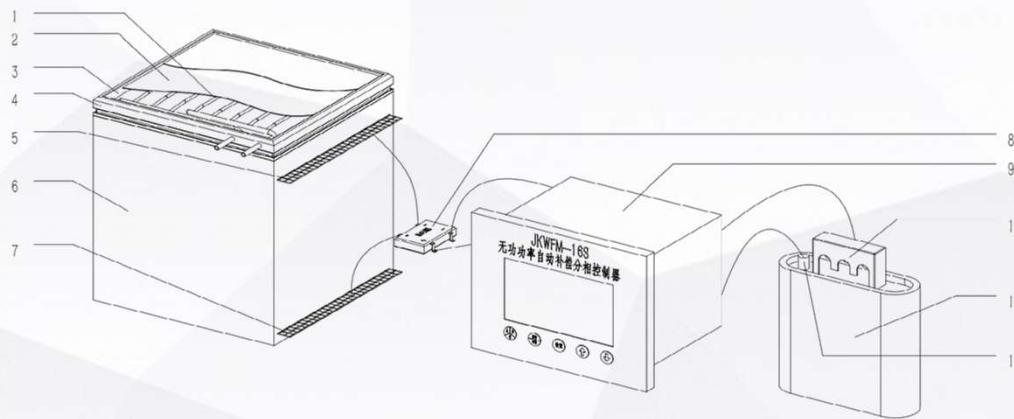

外墙曝晒与室内的制冷产生温差

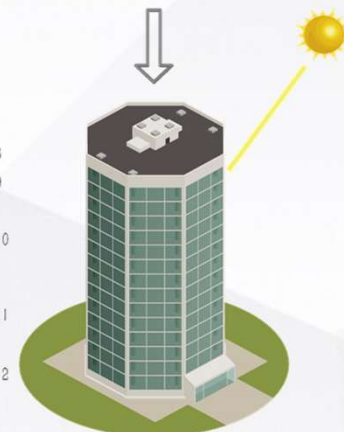

投入使用

# 道路自供应充放电

## 1 热能消纳利用

利用温差发电储电  
降低路面温度缓解城市热岛效应

## 2 路面压力传感

监测路面汽车运行，调度电力

## 3 嵌入式无线线圈

利用储电对新能源汽车边走边充

## 前景化应用场景二

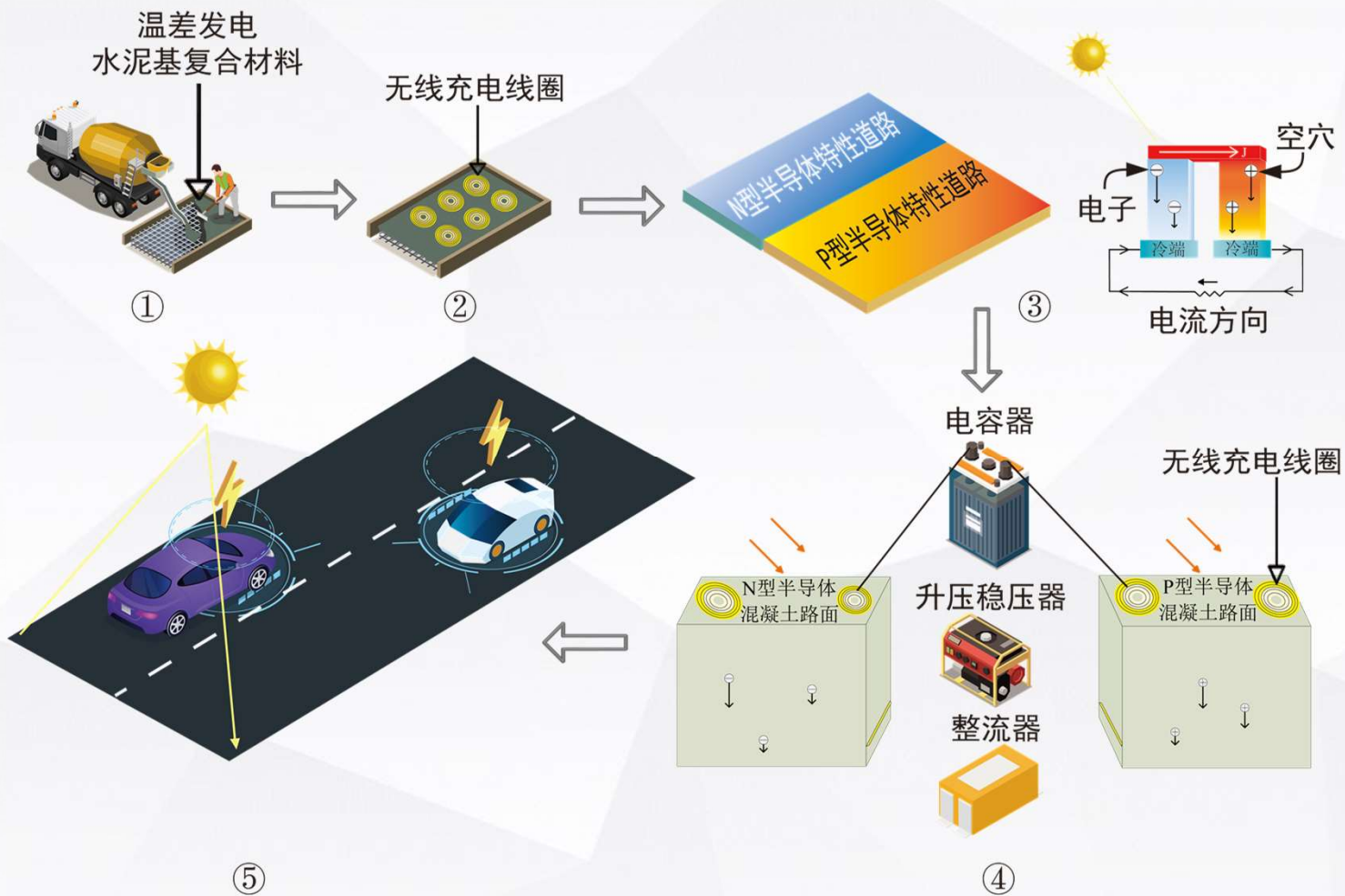

# 4

## 结果与讨论

---

## 模型验证

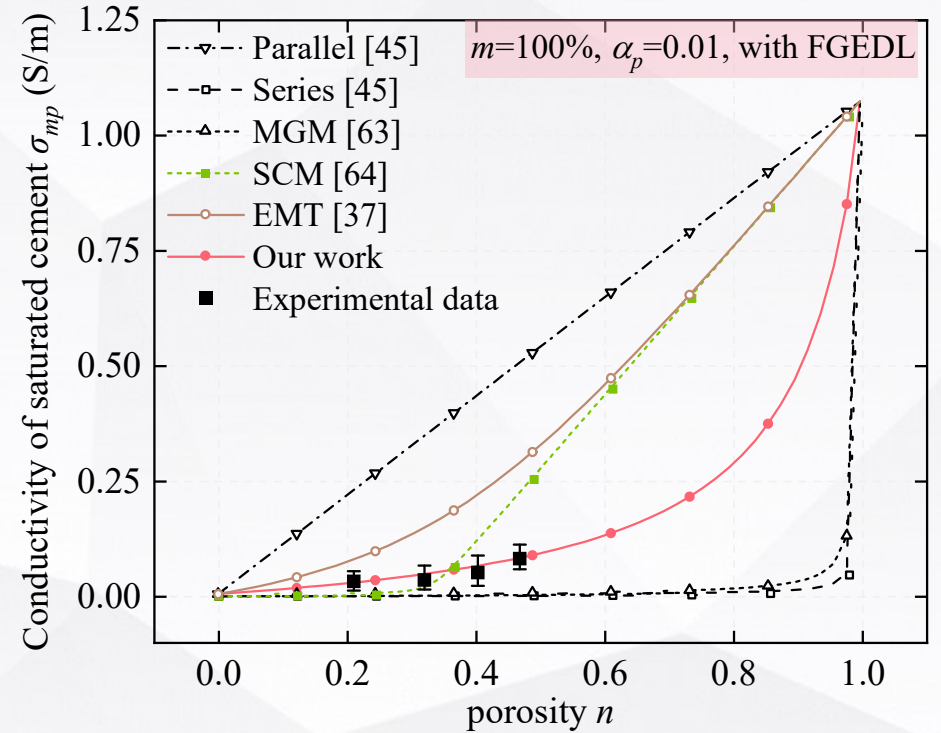
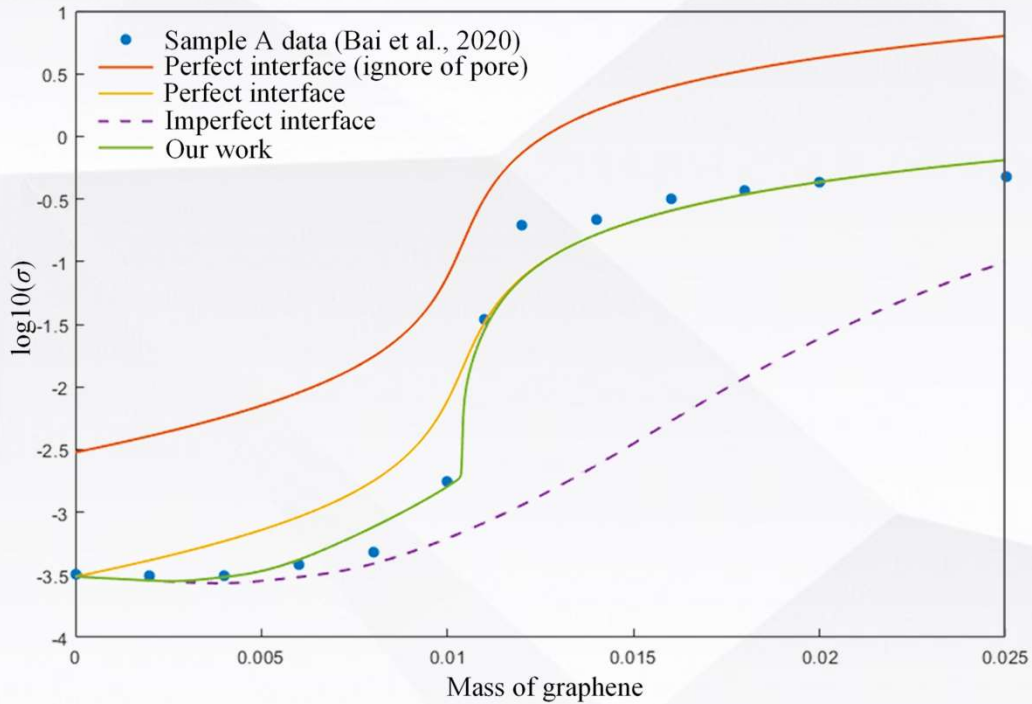

1. 建立的模型预测结果与实验结果吻合较好
2. 随着孔隙的增多，饱和浸润的水泥基复合材料导电性增加



## 两步法分析

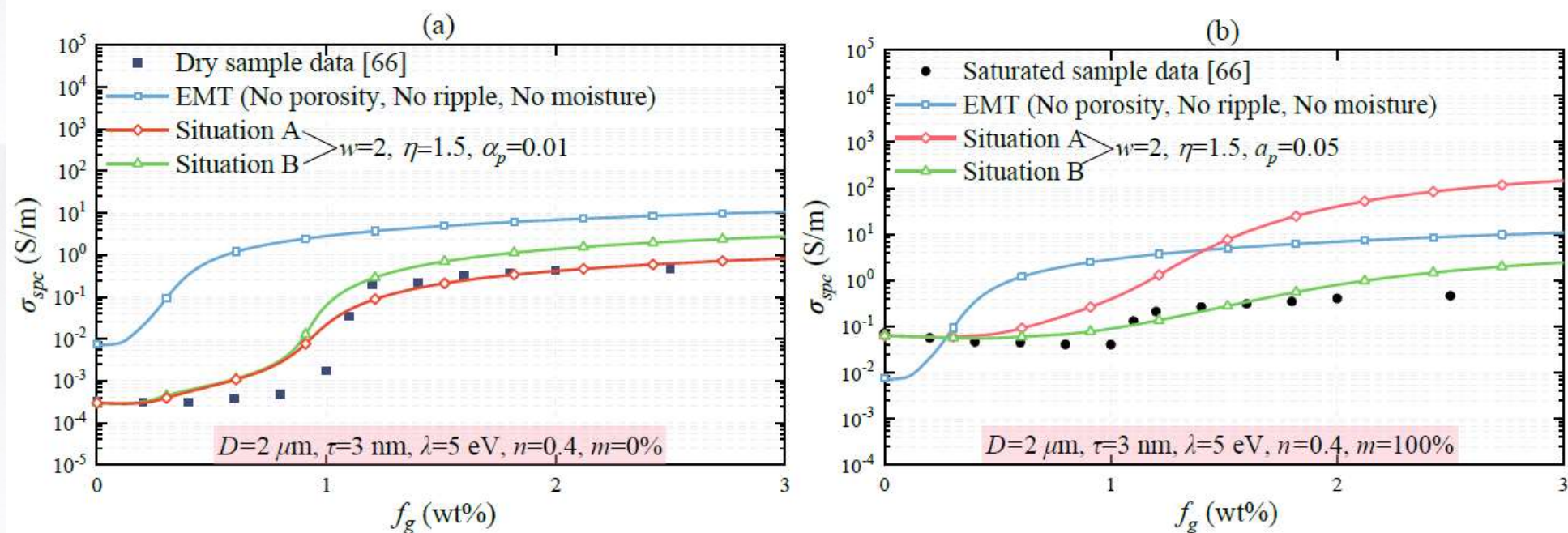

- ① 预测结果与实验结果吻合较好
- ② 对于干样品实验结果，采用A情况较好；对于浸润的样品，采用B情况较好

## 孔隙分析

- ① GNP填充直径在1-3  $\mu\text{m}$ 范围内的孔隙，增加了水泥样品中的微孔
- ② 两相界面引起的微裂缝对电导率有较大的削弱作用

(a)

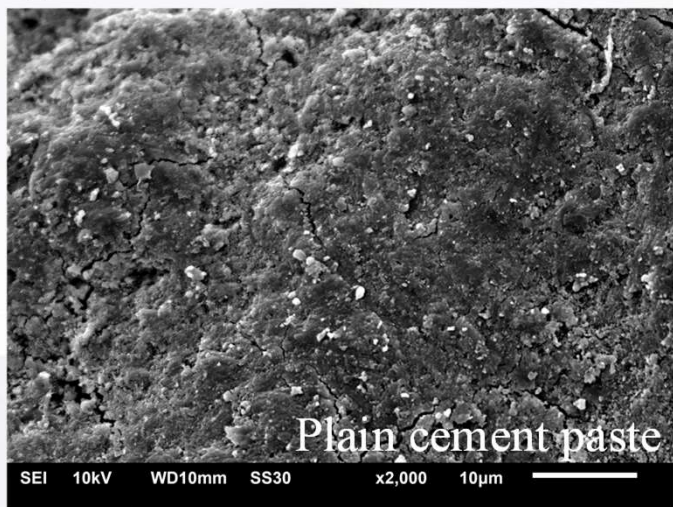

(b)

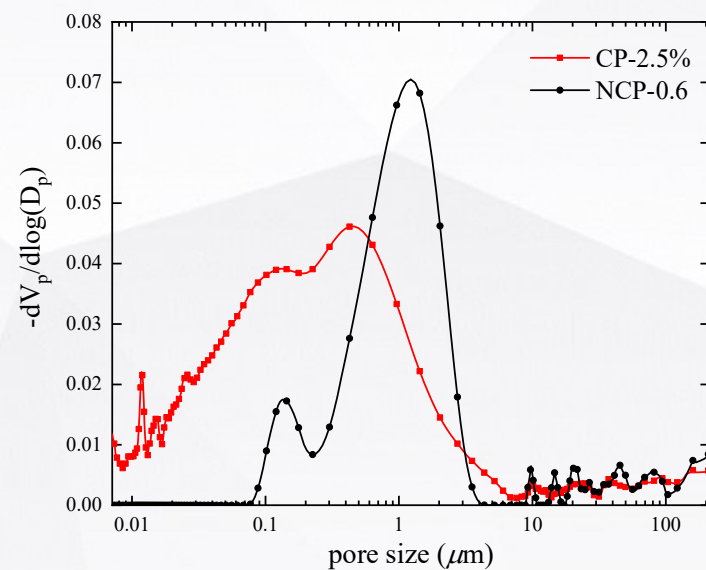
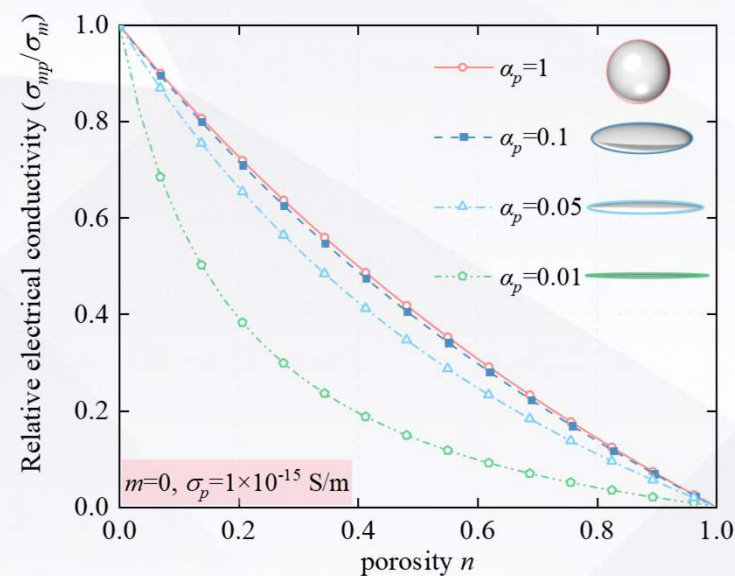
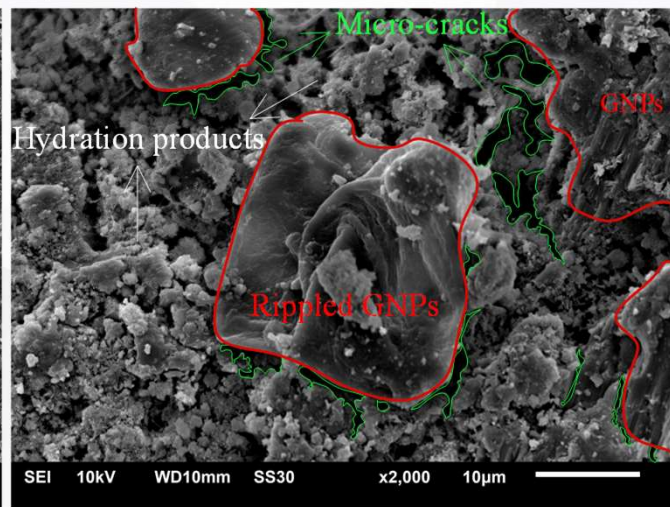

## 孔隙液分析

- ① 孔隙饱和度达到一定值后，离子导电网络形成，持续增加饱和度很难再提高整体电导率；细长孔隙相互搭接的可能性更大，从而形成离子通路，显著增强电导率。
- ② 孔隙液中的离子传导受限，不能像电子一样穿透水泥基体，产生隧道效应。

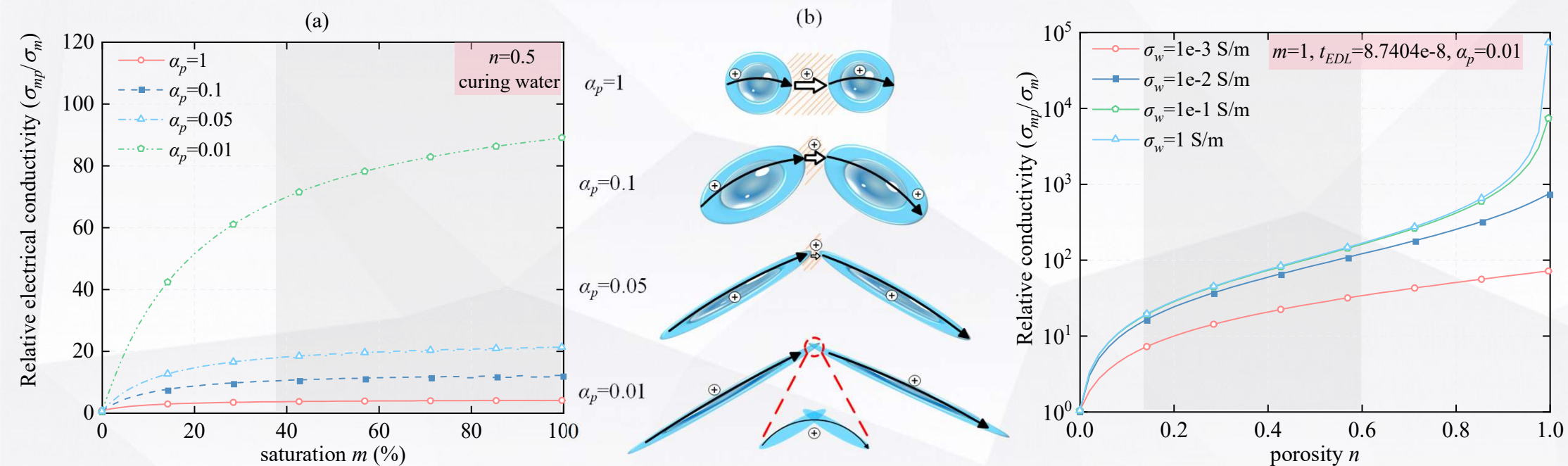

5

## 报告小结

---



- 建立了一种考虑孔隙和浸润液体的石墨烯增强水泥基复合材料导电性预测模型
- 对于干压法制备样品，需要先考虑石墨烯片，再考虑孔隙。对于湿法制备需要先考虑孔隙再考虑石墨烯片
- 孔隙和石墨烯片褶皱都会显著影响水泥基复合材料的逾渗行为和导电性。不考虑孔隙和石墨烯片褶皱将会导致严重高估导电性
- 对于浸润的多孔水泥基复合材料，研究发现浸润的样品的导电性比干样品的导电性大两个数量级